

Empower your GIS with the Power VT



Enhance your substation

Inductive voltage transformers (VT) are an essential part of high-voltage substations whether air- or gas insulated. They are typically used to provide measuring signals for control, protection and metering systems and thus ensure the reliability of the switchgear. With an improved design of the windings our voltage transformer (Power VT) becomes your high-voltage test equipment which then allows for standard high-voltage tests of the primary system.

Standards you can trust

Of course with the Power VT you can rely on all standard values of every common voltage transformer:

- Type-tested according to IEC 61869-1 and IEC 60044-2
- Rated voltage up to 170 kV
- Voltage factor 1.9 for 8 h
- Accuracy: class 0.2 at 100 VA class 0.5 at 200 VA
- Measuring frequency 50/60 Hz



Power VT high-voltage test set-up

Add more functionality

But with the Power VT you can benefit from additional functions compared to a standard component:

- High-voltage testing according to IEC standards and proposed test levels at your site (IEC 62271-203 table 107)
- Test frequency 100 HZ ± 20 %
- Test section up to 2 bays

Your benefits

- Test preparation within minutes allows re-testing at any time over the whole life cycle, e.g. after GIS-extension, reassembling or extensive service activities, quality and performance tests
- GIS operation can start directly after the test without mechanical work on the primary circuit and removing the high-voltage test set
- No extra space needed for temporary installation of huge high-voltage testing facilities
 - Low investments in site-based testing facilities
 - Stay independent as tests can be conducted by any neutral testing company worldwide
 - No need of large container with high-voltage test equipment
 - Small and lightweight testing equipment can be transported as carry-on luggage
 - Standard socket can be used as power supply (e.g. 3-phase, 400 V, 20 A)
 - High-voltage tests are as easy as testing a protection relay

- Our Power VTs are working in GIS substations for more than 8 years
- Approx. 200 Power VTs are currently in operation
- In 32 countries worldwide
- No incidents
- Also available for blue GIS® substations (SF₆-free)
- No SF₆-gas handling at site needed for test preparation

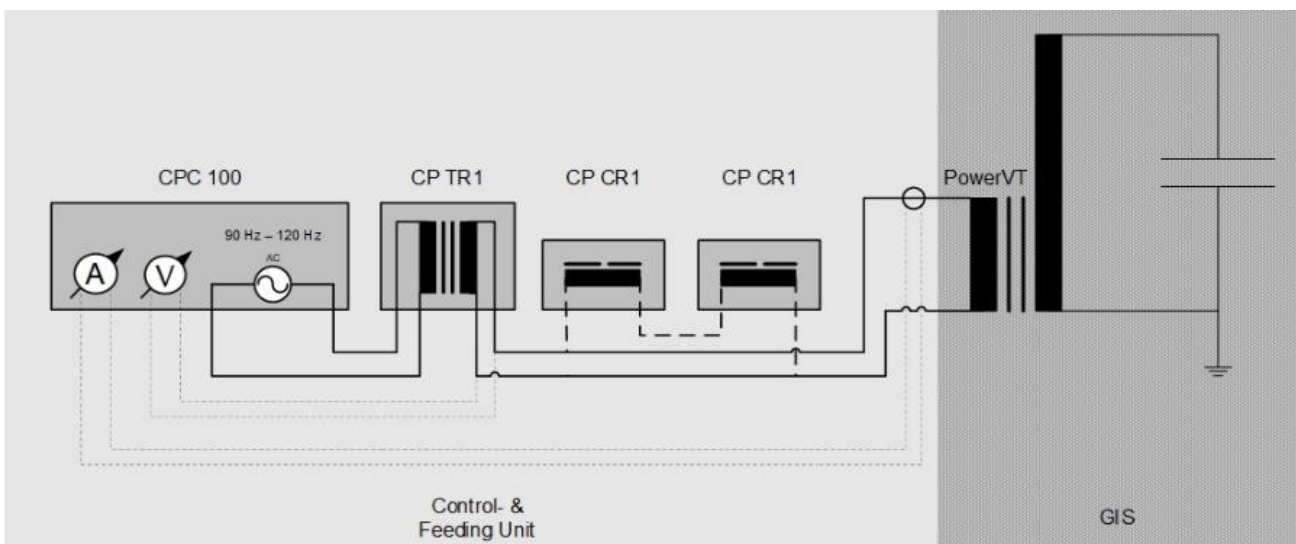

Simplified diagram for testing with Power VT

Examples for an optimal Power VT setup in a GIS

- Single busbar >5 with busbar section analyzer

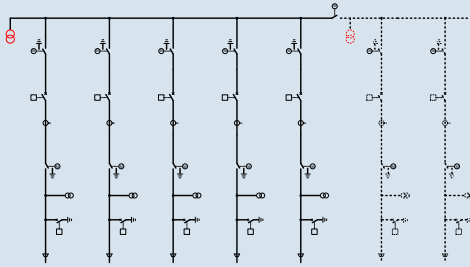

- Double busbar >5 with busbar section analyzer

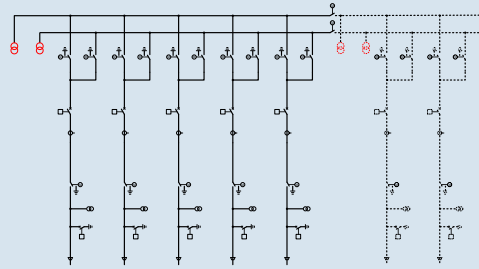

- Cable in the middle

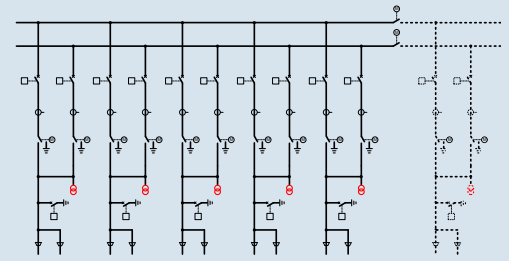

- Ring arrangements

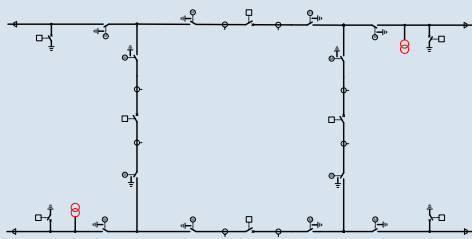

- H arrangements

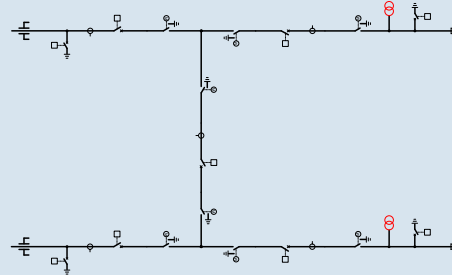

- 1 1/2 circuit-breaker arrangements

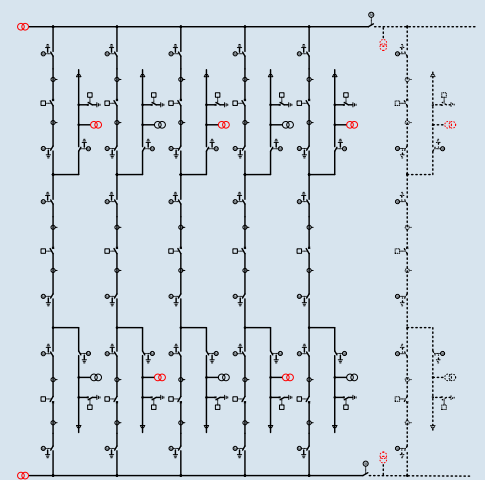

 Power VT instead of standard VT

Published by

Siemens Energy Global GmbH & Co. KG
 Freyeslebenstraße 1
 91058 Erlangen
 Germany

For more information, please visit our website:
[siemens-energy.com/gas-insulated-switchgear](https://www.siemens-energy.com/gas-insulated-switchgear)
 or contact us:
support@siemens-energy.com
circuit-breakers@siemens-energy.com

© Siemens Energy, 2021

Siemens Energy is a trademark licensed by Siemens AG.

Subject to changes and errors. The information given in this document only contains general descriptions and/or performance features which may not always specifically reflect those described, or which may undergo modification in the course of further development of the products. The requested performance features are binding only when they are expressly agreed upon in the concluded contract.

All product designations may be trademarks or product names of Siemens Energy Global GmbH & Co. KG or other companies whose use by third parties for their own purposes could violate the rights of the owners.